

K PUSH TECH

INSTALLATION TO BE EMBEDDED INSIDE THE PANEL

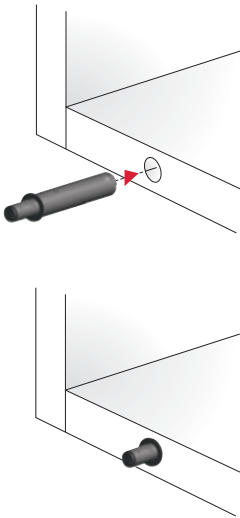

INSTALLATION THROUGH ADAPTER HOUSING

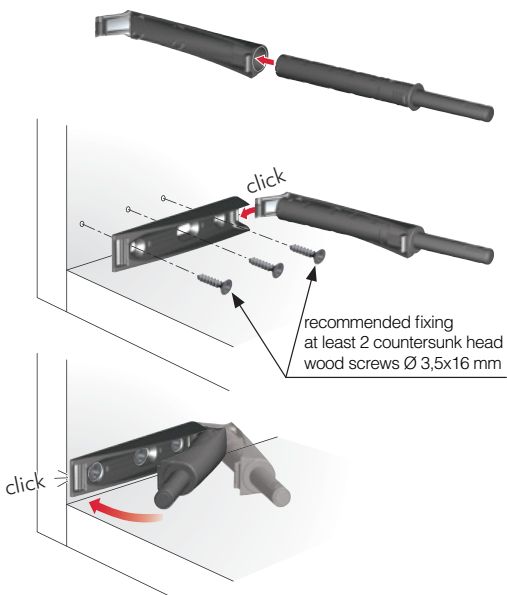

WITH MAGNET
for cabinets using **unsprung hinges**
or **negative hinges**.

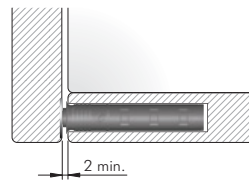

For details refer to
"K PUSH TECH AND
K LOCK DOOR PLATES".

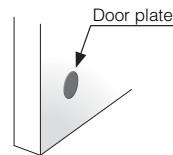

WITH BUFFER
for cabinets using **sprung hinges**.

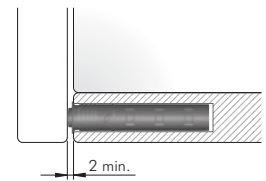

VERSIONS

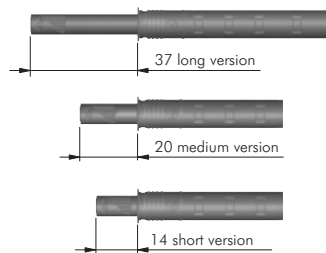

ADJUSTMENTS

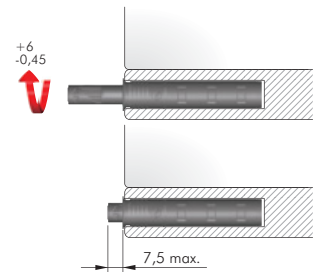

WITH MAGNET
for cabinets using **unsprung hinges**
or **negative hinges**.

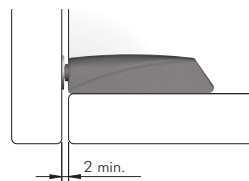

For details refer to
"K PUSH TECH AND
K LOCK DOOR PLATES".

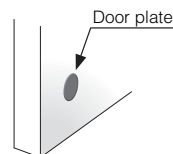

WITH BUFFER
for cabinets using **sprung hinges**.

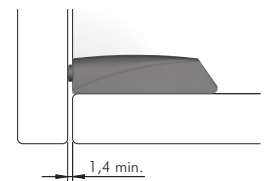

VERSIONS

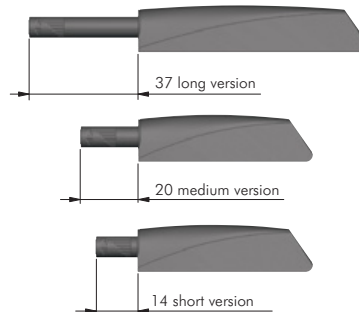

ADJUSTMENTS

